

# Paramount

## Convertible Burner

Model # : Item # :  
FP-REC FPB-RECT-002 and FPB-RECT-002MO  
FP-SQ FPB-SQ-001 and FPB-SQ-001MO  
FP-RD FPB-RD-002 and FPB-RD-002MO

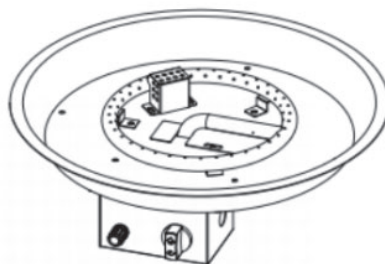
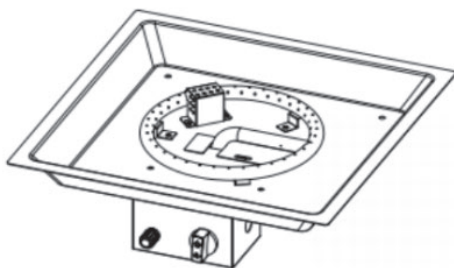
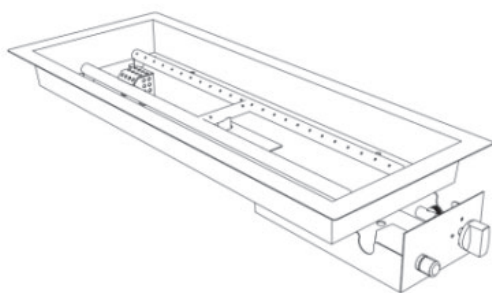

### **WARNING** FOR YOUR SAFETY

1. Improper installation, adjustment, alteration, service or maintenance can cause injury or property damage.
2. Read the installation, operation, and Maintenance instructions thoroughly before installing or servicing this equipment.
3. Failure to follow these instructions could result in fire or explosion, which could cause property damage, personal injury, or death.

### **WARNING**

For Outdoor Use Only

### **WARNING**

This product can expose you to chemicals including carbon monoxide which is known to the State of California to cause birth defects or other reproductive harm. For more information go to [www.P65Warnings.ca.gov](http://www.P65Warnings.ca.gov).



### **ATTACH YOUR RECEIPT HERE**

Keep a copy of your proof of purchase or order confirmation which will be needed if you need to contact us about warranty coverage.

Purchase Date: \_\_\_\_\_



### Questions, problems, missing parts?

*Before returning to your retailer, contact our exceptional customer service.*

Contact us by email at [customer care@jrhome.com](mailto:customer care@jrhome.com) or call us toll-free at (800) 561-5550, 7:30 a.m. – 4:00 p.m., PST, Monday – Friday .

# Paramount

## TABLE OF CONTENTS

Table of Contents/Before You Begin	Page 2
Safety Information	Page 3-4
Burner Information / Parts list	Page 5-8
Installation of Burner Into Enclosure	Page 8-10
Operating Instructions	Page 10-15
Care and Maintenance	Page 16
Troubleshooting	Page 17
Warranty Information	Page 17 -18
Converting from Propane to Natural Gas	Page 19-22



### BEFORE YOU BEGIN

Please read and understand this entire manual before attempting to assemble, operate or install this appliance.

This manual contains important information about the assembly, operation and maintenance of this appliance. General safety information is presented in the first few pages and is located throughout this manual. Keep this manual for future reference and to educate new users of this appliance.

## SAFETY INFORMATION

This appliance has been tested to and complies with the ANS Z 21.97-2017, Outdoor Decorative Gas Appliances CSA 2.41-2017 Outdoor Gas Fireplaces. The installation must conform to local codes or in the absence of local codes to the National Fuel Gas Code, ANS Z223.1. This manual contains important information about the assembly, operation and maintenance of this appliance. General safety information is presented in these first few pages and is also located throughout the manual. Keep this manual for future reference and to educate new users of this product. This manual should be read in conjunction with the labeling on the product. Safety precautions are essential when any mechanical or gas fueled equipment is involved. These precautions are necessary when using, storing, and servicing. Using the equipment with the respect and caution demanded will reduce the possibilities of personal injury or property damage. The following symbols shown below are used extensively throughout this manual. Always heed these precautions, as they are essential when using any mechanical or gas fueled equipment.

## WARNING

Failure to comply with the precautions and instructions provided with this appliance can result in death, serious bodily injury and property loss or damage from hazards of fire, explosion, burn, asphyxiation, and of carbon monoxide poisoning. Only persons who can understand and follow the instructions should use or service this appliance.

## WARNING / DANGER

WARNING/DANGER indicates an imminently hazardous situation which, if not avoided, will result in death or serious injury.

## WARNING

Do not store or use gasoline or other flammable vapors and liquids in the vicinity of this or any other appliance. An LP-cylinder not connected for use shall not be stored in the vicinity of this or any other appliance.

## DANGER

### EXPLOSION—FIRE HAZARD

- Keep solid combustibles, such as building materials, paper, or cardboard a safe distance away from the appliance as recommended by the instructions.
- Provide adequate clearances around air openings into the combustion chamber.
- Never use the appliance in spaces which do or may contain volatile or airborne combustibles, or products such as gasoline, solvents, paint thinner, dust particles, or unknown chemicals.
- During operation, this appliance can be a source of ignition. Keep appliance area clear and free from combustible materials, gasoline, paint thinner, cleaning solvents and other flammable vapors and liquids. Do not use the appliance in areas with high dust content. Minimum appliance clearances from combustible materials: 2 feet (24 inches) from the sides & 2 feet (24 inches) from the rear, 6 feet (72 inches) from ceiling.
- Never store propane near high heat, open flames, pilot lights, direct sunlight, other ignition sources or where temperatures exceed 120 degrees F (49 degrees C).
- Propane vapors are heavier than air and can accumulate in low places. If you smell gas, leave the area immediately.
- Never install or remove a propane cylinder while the appliance is lighted, near flame, pilot lights, or other ignition sources or while the appliance is hot to the touch. This appliance is red hot during use and can ignite flammables too close to the burner. Keep flammables at least 2 feet (24 inches) from top and 2 feet (24 inches) from sides. Keep gasoline and other flammable liquids and vapors well away from the appliance.
- Store the propane cylinder outdoors in a well ventilated space out of the reach of children. Never store the propane cylinder in an enclosed area (house, garage, etc.). If the appliance is to be stored indoors, disconnect the propane cylinder for outdoor storage.

## WARNING

Improper installation, adjustment, alteration, service or maintenance can cause property damage, injury or death. Read the installation, operation and maintenance instructions thoroughly before installing or servicing this equipment.

## DANGER

### FOR YOUR SAFETY

If you smell gas:

1. Shut off gas to the appliance.
2. Extinguish any open flame.
3. If odor continues, keep away from the appliance and immediately call your gas supplier or fire department.

## WARNING

We cannot foresee every use which may be made of our appliance. Check with your local fire safety authority if you have questions about your appliance use. Other standards govern the use of fuel gases and heat producing products for specific uses. Your local authorities can advise you about these. If no local codes exist, follow National Fuel Gas Code, ANS Z223.1. In Canada, installation must conform to local codes. If no local codes exist, follow the current National standards of CANADA CAN/CGA-B 149.2.

## WARNING: FOR OUTDOOR USE ONLY

### CARBON MONOXIDE HAZARD

This appliance is a combustion appliance. All combustion appliances produce carbon monoxide (CO) during the combustion process. This product is designed to produce extremely minute, non-hazardous amounts of CO if used and maintained in accordance with all warnings and instructions. Do not block air flow into or out of the appliance.

- Carbon Monoxide (CO) poisoning produces flu-like symptoms, watery eyes, headaches, dizziness, fatigue and possibly death. You can't see it and you can't smell it. It's an invisible killer. If these symptoms are present during operation of this product get fresh air immediately!
- For outdoor use only.
- Never use inside house, or other unventilated or enclosed area.
- This appliance consumes air (oxygen) Do not use in unventilated or enclosed areas to avoid endangering your life.

**DANGER****CARBON MONOXIDE HAZZARD**

**This appliance can produce carbon monoxide which has no odor.**

**Using it in an enclosed space can kill you.**

**Never use this appliance in an enclosed space such as a camper, tent, car or home.**

**DANGER**

If you smell gas:

1. Shut off gas to the appliance.
2. Extinguish any open flame.
3. If odor continues, keep away from the appliance and immediately call your gas supplier or fire department.

**WARNING**

Do not store or use gasoline or other flammable vapors and liquids in the vicinity of this or other appliance.

An LP-cylinder not connected for use shall not be stored in the vicinity of this or any other appliance.

**WARNING**

Do not leave unattended during use.  
Do not use for cooking.  
Follow all gas leak procedures in this manual prior to operation.

**WARNING**

Improper installation, adjustment, alteration, service or maintenance can cause injury or property damage. Read the installation, operating and maintenance instructions thoroughly before installing or servicing this equipment

**WARNING:** If the information in these instructions is not followed exactly, a fire or explosion may result causing property damage, personal injury or death.

**FOR YOUR SAFETY**

Do no store or use gasoline or other flammable vapors and liquids in the vicinity of this or another appliance.

# BURNER INFORMATION

*Paramount*

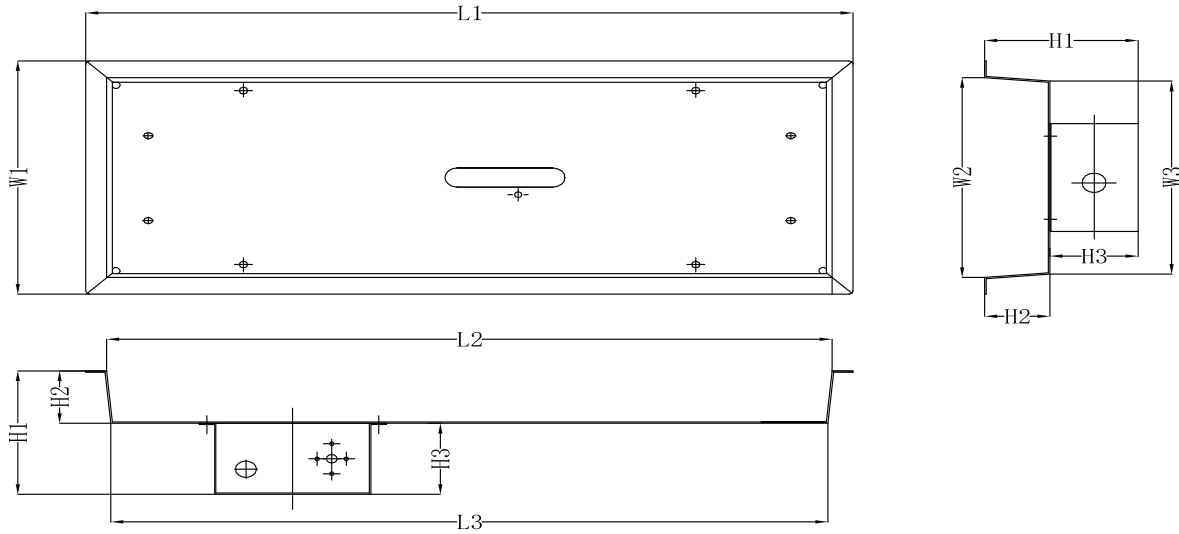

Fire Pit pan

fire pit pan size and embedded panel			
L	L1	L2	L3
	X1	X2	/
W	W1	W2	W3
	Y1	Y2	/
H	H1	H2	H3
	Z	/	/

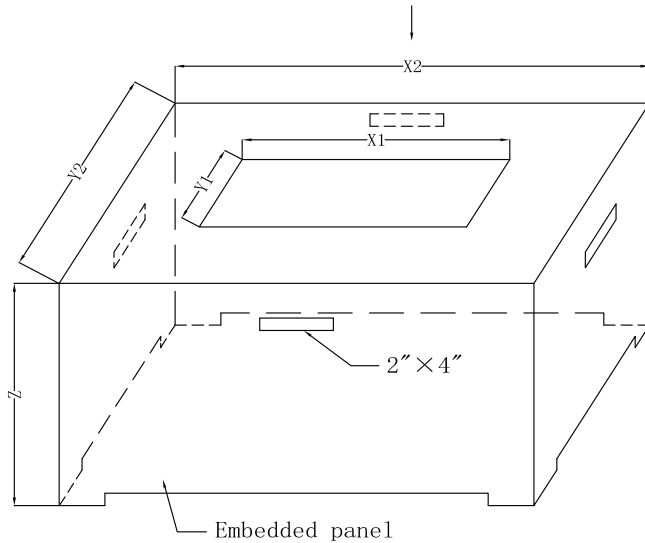

Measurement : MM

Mold	Dimension	ULC-PC75-H-E	ULC-PZ48-C-E	ULC-PY54-C-E
L	L1	726	480	545
	L2	676	438.8	495
	L3	620.1	376.3	436.3
W	W1	354	480	X
	W2	304	438.8	X
	W3	223.9	376.3	X
H	H1	134	144	144
	H2	50.8	50.8	50.8
	H3	83.2	93.2	93.2
X	X1	732	486	552
	X2	1220	1070	1120
Y	Y1	360	486	552
	Y2	914	1070	1120
Z	Z	610	610	610

**BURNER (RECTANGLE)** Model no.: ULC-PC75-H-E

*Paramount*

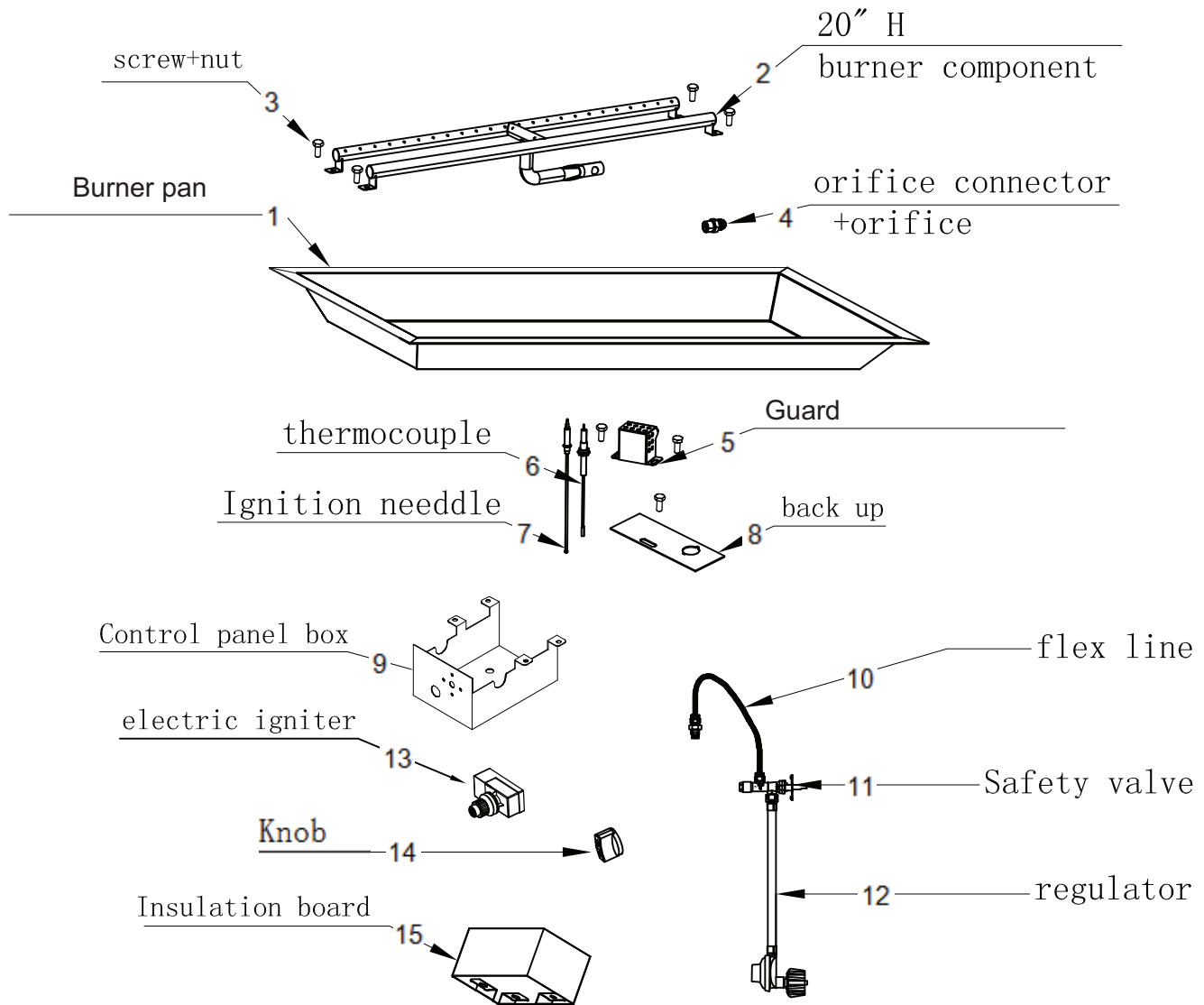

NO	Components	Specification	Quantity
1	Burner pan	Rectangle	1
2	Burner	H shape	1
3	Screw+nut	sus304	4
4	Orifice+connector	copper	1
5	Guard	sus304	1
6	Thermocouple		1
7	Ignition needle		1
8	Back up	sus304	1
10	Flex line	sus304	1
11	Safe Valve	copper+sus304	1
12	Regulator	PVC+Zinc+ Alu. Alloy	1
13	Electric Igniter		1
14	Knob	Zinc Alloy	1
15	Insulation board		1

**BURNER (SQUARE)** Model no.:ULC-PZ48-C-E

*Paramount*

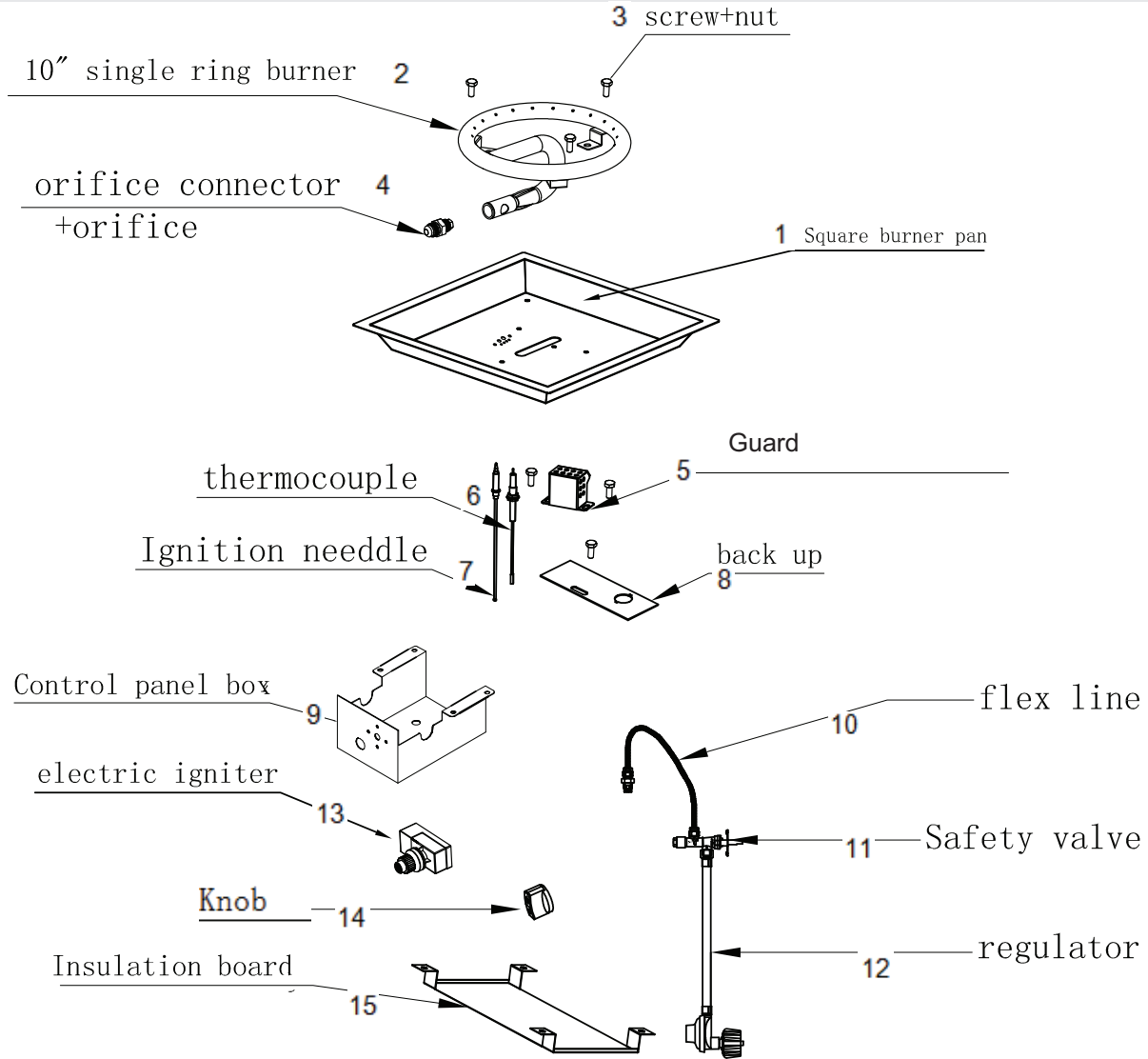

NO	Components	Specification	Quantity
1	Burner pan	Square	1
2	Burner	single ring	1
3	Screw+nut	sus304	3
4	Orifice+connector	copper	1
5	Guard	sus304	1
6	Thermocouple		1
7	Ignition needle		1
8	Back up	sus304	1
9	Control panel box	sus201+black coating	1
10	Flex line	sus304	1
11	Safe Valve	copper+sus304	1
12	Regulator	PVC+Zinc+ Alu. Alloy	1
13	Electric Igniter		1
14	Knob	Zinc Alloy	1
15	Insulation board		1

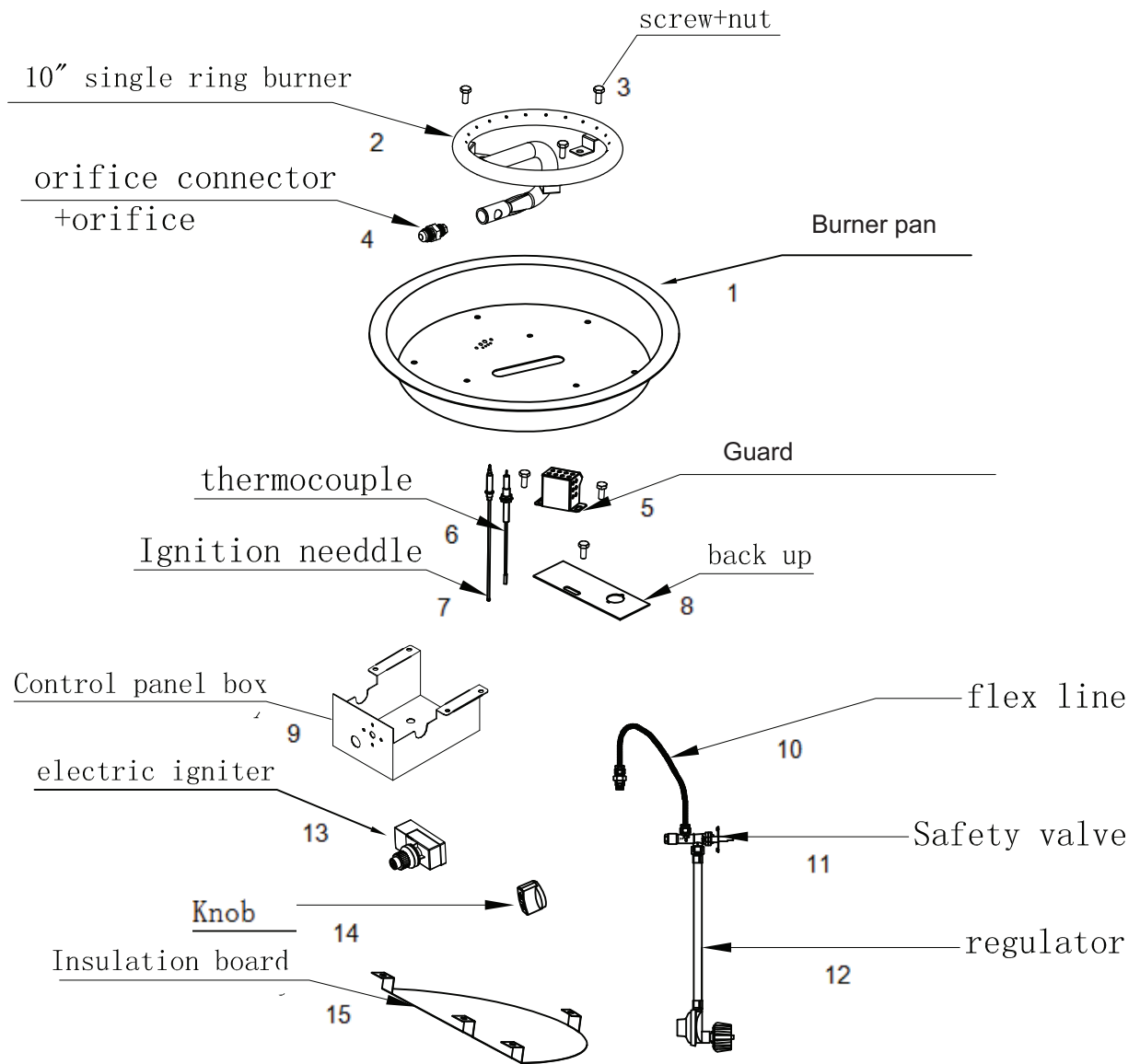

NO	Components	Specification	Quantity
1	Burner pan	Round	1
2	Burner	single ring	1
3	Screw+nut	sus304	3
4	Orifice+connector	copper	1
5	Guard	sus304	1
6	Thermocouple		1
7	Ignition needle		1
8	Back up	sus304	1
9	Control panel box	sus201+black coating	1
10	Flex line	sus304	1
11	Safe Valve	copper+sus304	1
12	Regulator	PVC+Zinc+ Alu. Alloy	1
13	Electric Igniter		1
14	Knob	Zinc Alloy	1
15	Insulation board		1



## FIRE BEADS INSTALLATION GUIDELINES

- A. Carefully inspect the carton for shipping damage. If any parts are missing or damaged, call your customer assistance. **Do not attempt** to install the appliance unless all parts are in good condition.
- B. Correct installation is crucial to safe performance of your Outdoor Fire Pit.
- C. Due to high temperatures, the Fire Pit must be located out of traffic areas and away from combustibles.

## FIRE BEADS PLACEMENT

**CAUTION – Cuts may occur from the sharp edges on fire beads. Use safety gloves during the placement of glass.**

Pour the bag of fire beads into the Outdoor Fire Pit so that the burner is completely covered.  
(See figures #1 and #2). These instructions apply to both round and rectangular burners.

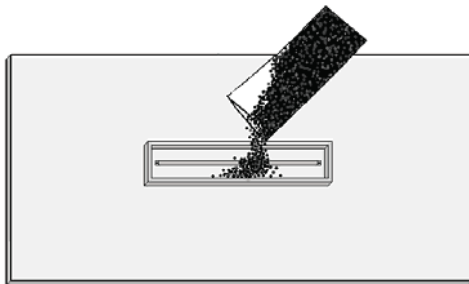

Figure 1

Top View

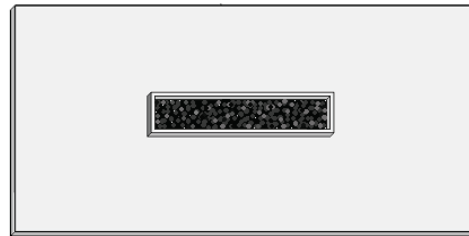

Figure 2

**CAUTION: BURN HAZARD. FIRE BEADS WILL REMAIN HOT FOR SOME TIME AFTER USE. YOU MUST MAINTAIN THE LAYOUT AS SHOWN TO ENSURE PROPER OPERATION OF YOUR FIRE PIT. IF YOU NEED TO REPOSITION ANY MATERIAL TO MAINTAIN THE PROPER LAYOUT, USE HEAT RESISTANT GLOVES OR ALLOW MATERIAL ADEQUATE TIME TO COOL BEFORE HANDLING.**

## **REQUIREMENTS**

1. Only non-combustible materials should come in direct contact with any part of the Fire Pit. Underneath area should be non-combustible as well.
2. Only use ¾" gas supply line to the Fire Pit. Based on the selection of the fire pit size, the proper brass fittings should be used to ensure a proper installation.
3. Determine the size of the Fire Pit you are preparing to install (Refer to page 3).
4. You must provide a cut out to place the fire pit into the non-combustible enclosure surround.
5. Follow the local code requirements for the gas type being used. This Fire Pit should be installed in accordance with local codes and ordinances or in the absence of local codes, with the latest National Fuel Gas Code, ANSI Z223.1 NFPA54 or CSA B149.1, Natural and Propane Installation Code in Canada.
6. Fire Pits create high temperatures, it is very important to have any combustibles at a safe distance.
7. Fire pit should never be left unattended while in operation. It should always be a safe distance from all trees and combustible landscape materials.
8. Construction of the finished fire pit should be stable and solid. From the bottom of the control box that houses the gas valve and module, it should be a minimum of 4-inches to the ground level. See figure #1. Drainage is critical to ensure that water does not damage and valve components. Never install the fire ring system below grade.
9. **CAUTION: A minimum of 18 square inches of cross ventilation (2 sides) is required to keep the components in good working order.**
10. The insulation square pad provided with the Fire Pit is to be placed foil up toward the bottom of pan on top of the valve box.
11. Never fill the cavity under and around the valve box with any material, this is a provided air space necessary for ventilation.
12. These products are designed for outdoor use only. Not approved for any indoor use.
13. This Fire Pit is designed to have firebeads covering the burner. When purchasing decorative rock it is recommended to use minimum of 1-inch diameter rock as a base to fill the burner pan. Decorative glass may be loosely scattered on top of rock if desired or non-combustible logs may be added for a campfire look. **NOTE:** If using all glass media, glass must be a minimum of 1/4-inch diameter or larger.
14. Gas lines and fittings must be installed in to the non-combustible structure. All gas connections must be leak tested before installation of the fire pit. Soapy water leak detection is required before regular use of the fire pit.
15. Do not use material that will absorb moisture over time and will not release this moisture quickly. Moisture can boil in this material and can rapidly break apart and cause damage or personal injury.
16. Never leave any other combustible material on top of the fire pit. This could cause unsafe operation of this system and damage to the component that will not be covered under our warranty.
17. Cover the complete burner with fire beads (min. 1-inch deep). Completely cover the burner, no more than 1 inch above the burner. Do not cover the screen guard.

## ▲ WARNING

**\*Do not use this fire pit for cooking.**





- \*Do not burn any other materials than are supplied with and intended for use in this fire pit.
- \*Do not pour water into fire pit.
- \*The installation of this product must conform with local codes.
- \*Do not use this fire pit if any part has been under water.
- \*Do not store a spare or disconnected liquid propane cylinder under or near this fire pit.
- \*After a period of storage, and/or non use, the propane fire pit should be checked for gas leaks and burner obstructions before use.
- \*Do not operate the propane fire pit if there is a gas leak present.
- \*Never use a flame to check for gas leaks.
- \*Combustible materials should never be within 10 feet of the top, back or sides of your propane fire pit.
- \*Do not put any other fire pit cover or anything flammable on, or beneath the fire pit.
- \*The propane fire pit should never be used by children. Children must be supervised when they are anywhere near the appliance.
- \*Users should be alerted to the hazards of high surface temperatures and keep a safe distance to avoid burning or clothing ignition.
- \*Pay attention when operating the fire pit. It is hot in use and should never be left unattended. Do not move it while in operation.
- \*Should fire go out while burning, turn the gas valve off. Follow the instruction and wait five minutes before attempting to relight.
- \*Never use charcoal or any other solid fuel in the fire pit. Never put clothing or other flammable materials on or near the fire pit.
- \*Never lean over the open fire pit or place hands or fingers on the upper portion of an operational unit.
- \*Keep ventilation openings in cylinder enclosure(FIRE PIT BODY) free and clear of debris.
- \*Do not rest feet on the fire pit.
- \*Please take out the battery when not using the fire pit for an extended length of time.
- \*Do not enlarge valve orifices or burner ports when cleaning the valve or burner.
- \*Cylinder supply system must be arranged for vapor withdrawal
- \*LP Tank used must include a collar to protect the cylinder valve
- \*Never fill the cylinder beyond 80% full
- \*Liquid propane gas is not natural gas. Only use propane for this fire pit.
- \*The conversion or attempted use of natural gas in a liquid propane unit or liquid propane gas in a natural gas unit is dangerous and should only be done by a service person.
- \*Do not use this fire pit on vehicles or boats. Always operate the appliance on flat ground outdoors.
- \*Keep any electrical supply cord and the fuel supply hose away from any heated surfaces.
- \*Do not use this fire pit unless all parts are in place.
- \*Keep the appliance area clear and free from combustible materials, gasoline, and other flammable vapors and liquids.
- \*Inspect the hose before each use of the appliance
- \*The hose assembly must be replaced prior to the appliance being put into operation if there is evidence of excessive abrasion or wear or if the hose is damaged.
- \* If the pvc component is damaged ,please send email to [customercare@jrhome.com](mailto:customercare@jrhome.com)
- \* Locating the hose out of pathways where people may trip over it or in areas where the hose may be subject to accidental damage.
- \* the burner must be replaced prior to the appliance being put into operation if it is evident that the burner is damaged.
- \* If the burner component be damaged,please send email to [customercare@jrhome.com](mailto:customercare@jrhome.com)

The LP-gas supply cylinder to be used must be:

- 1) constructed and marked in accordance with the U.S. Department of Transportation(D.O.T.) Specifications for LP-Gas Cylinders, or the Standard for Cylinders, Spheres and Tubes for Transportation of Dangerous Goods and Commission, CAN/CSA-B339, as applicable;
- 2) provided with a listed overfilling prevention device; and
- 3) provided with a cylinder connection device compatible with the connection for the appliance.

## FOR LIQUID PROPANE GAS UNITS

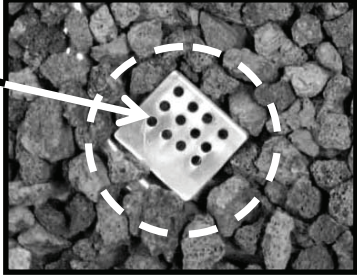
- \*Do not attempt to disconnect the gas regulator or any gas fitting while your fire pit is in operation.
- \*A dented or rusty liquid propane cylinder may be hazardous and should be checked by your gas supplier prior to use.
- \*Do not use a liquid propane cylinder with a damaged valve and any other worn out parts.
- \*Transit and store the empty gas cylinders carefully and properly.
- \*If you see, smell or hear the hiss of escaping gas from the liquid propane cylinder:
  1. Turn off the gas supply and get away from the gas cylinder and the fire pit at once.
  2. Do not attempt to correct the problem yourself.
  3. Get to your gas supplier and/or the fire department for help.

 <h3 style="margin: 0;"><u>WARNING</u></h3>	<p style="margin: 0;"><b>Guard</b> </p>  <p style="margin: 0;"><b>Do not place fire beads or lava rocks in this area. Keep this area clear.</b></p>
 <p style="margin: 0;">This guard must be clear and free of obstructions at all times to insure proper operation.</p>	

## OPERATION

**CAUTION:** Children and adults should be alerted to the hazards on high surface temperatures and should stay away to avoid burns or clothing ignition. Young children should be carefully supervised when they are in the area of the appliance.

**WARNING:** Do not use this appliance if any part has been under water. Immediately call a qualified service technician to inspect the appliance and to replace any part of control system and any gas control, which has been under water.

### SAFETY WARNINGS

1. Never leave the Fire Pit unattended during operation.
2. Clothing or other flammable materials should not be placed on or near the appliance.
3. Any guard or other protective device removed for servicing the appliance must be replaced prior to operating the appliance.
4. Installation and repair should be done by a qualified service person. The appliance should be inspected before use and at least annually by a qualified service person. More frequent cleaning may be required as necessary. It is imperative the control compartment, burners and circulating air passageways of the appliance be kept clean.
5. Inspect the fuel supply connection before each use of the appliance.
6. Temporary storage of this appliance indoors is permissible only if it has been disconnected from its fuel supply (Natural or L.P. gas line).

### WARNING

1. This appliance is hot when operated and can cause severe burns if contacted.
2. Do not burn any solid fuels in this appliance.

## LEAK CHECK

### ⚠ WARNING!

- Perform all leak tests outdoors.
- Extinguish all open flames.
- NEVER leak test when smoking.
- Do not use the appliance until all connections have been leak tested and do not leak

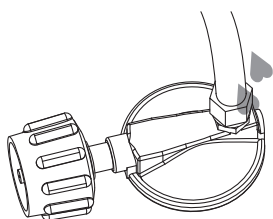

Hose / Regulator  
Connection

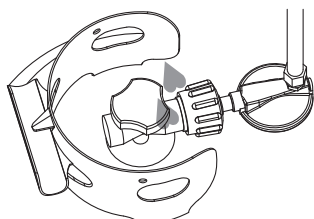

Regulator / Cylinder  
Connection

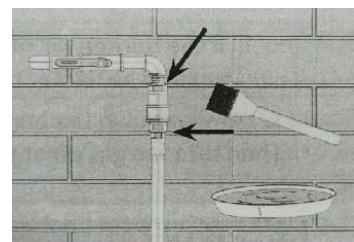
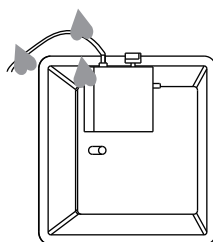

1. Make 2-3 oz. of leak test solution (one part liquid dishwashing detergent and three parts water).
2. Apply several drops of solution where hose attaches to regulator.
3. Apply several drops of solution where regulator connects to cylinder.
4. Make sure all valves are turned OFF.
5. Turn cylinder valve ON.

**If bubbles appear at any connection there is a leak.**

1. Turn cylinder valve OFF.
2. If leak is at hose/regulator connection: tighten connection and perform another leak test. If bubbles continue appearing, the hose should be returned to the place of purchase.
3. If leak is at regulatory/cylinder valve connection: disconnect, reconnect, and perform another leak test. If you continue to see bubbles after several attempts, cylinder valve is defective and should be returned to cylinder's place of purchase.

**If NO bubbles appear at any connection, the connections are secure.**

**NOTE: Whenever gas connections are loosened or removed, you must perform a complete leak test. Complete installation.**

# OPERATING INSTRUCTIONS

# Paramount

## CAUTION

Do not attempt to operate until you have read and understand all General Safety Information in this manual and all assembly is complete and leak test has been performed.

## BEFORE TURNING GAS SUPPLY ON:

1. Your appliance was designed and approved for outdoor use only. Do NOT use it inside a building, garage, or any other enclosed area.
2. Make sure surrounding areas are free of combustible materials, gasoline, and other flammable vapors or liquids.
3. Ensure that there is no obstruction to air ventilation. Be sure all gas connections are tight and there are no leaks.
4. Be sure the cylinder is clear of debris. Be sure any component removed during assembly or servicing is replaced and fastened prior to starting.

NOTE: This model has an Electronic Igniter and will require installation of 1-AAA battery. The battery should be installed by unscrewing the RED IGNITER BUTTON.



Electronic igniter requires AAA battery

## BEFORE LIGHTING:

1. The appliance should be thoroughly inspected before each use, and by a qualified service person at least annually. If relighting a hot appliance, always wait 5 minutes with tank valve closed.
2. Inspect the hose assembly for evidence of excessive abrasion, cuts, or wear. Suspected areas should be leak tested. If the hose leaks, it must be replaced prior to operation. Only use the replacement hose assembly specified by manufacturer.

## LIGHTING:

1. Turn the control knob to "OFF" position. (Figure A)
2. (Natural Gas skip to Step 3) Fully open LP cylinder valve. *Note: For initial start or after any cylinder change, hold Control knob IN for 2 minutes to purge air from gas lines before proceeding.*
3. Push in gas control knob and turn counterclockwise to "HIGH" (Figure B). Press igniter button. If needed, return gas control knob to "OFF" and repeat these steps until the fire pit lights (you should hear a clicking sound each time).
4. After the appliance lights, release control knob. If you want a lower temperature push in the control knob and turn clockwise to the "LOW" Position (Figure C).

**NOTE: If burner fails to remain lit, close all valves and wait at least 5 minutes for accumulated gas to dissipate before attempting to light.**

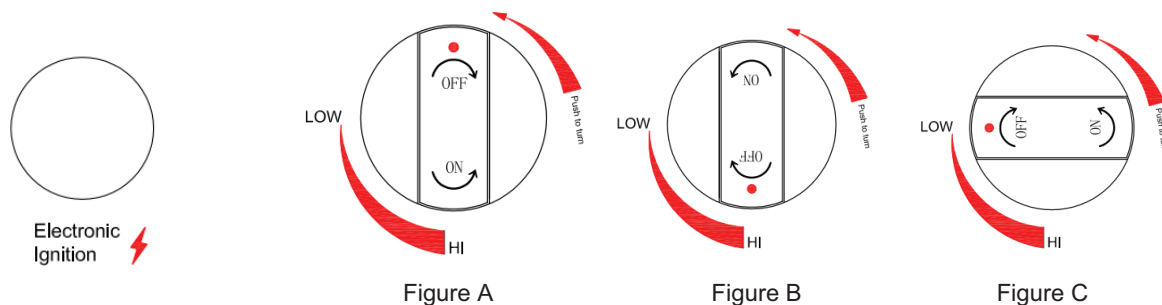

Contact us for assistance: [customer@jrhome.com](mailto:customer@jrhome.com) | (800) 561-5550



## OPERATION CHECKLIST:

For a safe and pleasurable heating experience, perform this check before each use:

### BEFORE OPERATING:

- I am familiar with entire owner's manual and understand all precautions noted.
- All components are properly assembled, intact and operable.
- No alterations have been made.
- All gas connections are secure and do not leak.
- Wind velocity is below 10 mph.
- Appliance is for use outdoors (outside any enclosure).
- There is adequate fresh air ventilation.
- Appliance is away from gasoline or other flammable liquids or vapors.
- Appliance is away from windows, air intake openings, sprinklers and other water sources.
- Appliance is at least 4 feet (48 inches) on top and at least 2 feet (24 inches) on sides from combustible materials.
- Appliance is on a hard and level surface.
- There are no signs of spider or insect nests in burner orifices.
- All burner passages are clear.
- All air circulation passages are clear.
- Clothing or other protective material should not be hung from the appliance, or placed on or near the appliance.
- Any guard or other protective device removed for servicing the appliance must be replaced prior to operating the appliance.
- Installation and repair should be done by a qualified service person. The burner should be inspected before each use and at least annually by a qualified service person.

### OPERATION INFORMATION AND SAFETY:

- Unit will operate at reduced efficiency below 40 degrees F.
- Children and adults should be alerted to the hazards of high surface temperatures and should stay away to avoid burns or clothing ignition.
- Young children should be carefully supervised when they are in the area of the appliance
- More frequent cleaning may be required as necessary. It is imperative that control compartment burner and circulating air passageways of the appliance be kept clean and free of debris and/or spider or insect nests.

## WARNING

### FOR YOUR SAFETY

Be careful when attempting to manually ignite this appliance. Holding in the control knob for more than 10 seconds before igniting the gas will cause a ball of flame upon ignition.

## WARNING

### FOR YOUR SAFETY

Appliance will be hot after use. Handle with care.



## SHUT DOWN:

1. To extinguish burner depress control knob and continue to turn it clockwise to OFF.
2. Turn cylinder valve clockwise to OFF and disconnect regulator when not in use for long periods



## AFTER OPERATION:

1. Gas control knob is in OFF position.
2. Gas tank valve is OFF.
3. Disconnect gas line.

To enjoy years of outstanding performance from your burner, make sure you perform the following maintenance activities on a regular basis:

1. Use warm soapy water for cleaning. Never use flammable or corrosive cleaning agents.
2. While cleaning your unit, be sure to keep the area around the burner and control compartment dry at all times. Do not submerge the control valve assembly. If the gas control is submerged in water, do NOT use it. It must be replaced. Make sure fire pit has cooled completely before cleaning or covering with a cover.
  - A. Keep the appliance area clear and free from combustible materials, gasoline and other flammable vapors and liquids.
  - B. Do not obstruct the flow of combustion and ventilation air.
  - C. Keep the ventilation opening(s) of the cylinder enclosure free and clear from debris.
3. Air flow must be unobstructed. Keep controls, burner, and circulating air passageways clean. Signs of possible blockage include:
  - Gas odor with extreme yellow tipping of flame.
  - Fire pit does NOT reach the desired temperature.
  - Fire pit glow is excessively uneven.
  - Fire pit makes popping noise.
  - Spiders and insects can nest in burner or orifices. This dangerous condition can damage fire pit and render it unsafe for use. Clean burner holes by using a heavy-duty pipe cleaner. Compressed air may help clear away smaller particles.
  - Carbon deposits may create a fire hazard. Clean burner screen with warm soapy water if any carbon deposits develop.



*Note: In a salt-air environment (such as near an ocean), corrosion occurs more quickly than normal. Frequently check for corroded areas and repair them promptly.*

## SERVICE:

Only a qualified service person should repair gas passages and associated components.

**Caution:** Always allow to cool before attempting service.

## WARNING

### FOR YOUR SAFETY

- Do NOT touch or move fire pit for at least 45 minutes after use.
- Burner is hot to the touch.
- Allow burner to cool before touching.

## STORAGE:

### Between uses:

- Turn control knob OFF.
- Disconnect LP source.
- Store fire pit in an area sheltered from direct contact with inclement weather (such as rain, sleet, hail, snow, dust and debris).
- If desired, cover fire pit to protect exterior surfaces and to help prevent build-up in air passages.

### During periods of extended inactivity or when transporting:

- Turn control knob OFF.
- Disconnect LP source and move to a secure, well-ventilated location outdoors.
- Store fire pit in an area sheltered from direct contact with inclement weather (such as rain, sleet, hail, snow dust and debris).
- If desired, cover the burner to protect exterior surfaces and to help prevent build-up in air passages. Never leave LP cylinder exposed to direct sunlight or excessive heat.

**Note:** Wait until fire pit is cool before covering.



PROBLEM	POSSIBLE CAUSE	CORRECTIVE ACTION
Burner will not light	Propane cylinder is frosted over	Wait until the propane cylinder warms up and becomes unfrosted
	Blockage in orifice	Clear blockage
	Control knob is not in ON position	Turn control knob to ON
Burner flame is low	Gas pressure is low	Turn cylinder valve OFF and replace cylinder
	Outdoor temperature is less than 40°F and tank is less than 1/4 full	Use a full cylinder
	Control knob fully ON	Check burner and orifices for blockage
Carbon build-up Thick Black Smoke	Dirt or film on burner screen	Clean burner screen
	Blockage in burner	Remove blockage and clean burner screen inside and outside.

## Extend Your Warranty By Leaving A Review

We want your opinion about your purchase...and we want you to tell everyone about it! Just leave a review for the product on the retailers website where you made your purchase, or at [www.jrhome.com](http://www.jrhome.com), and fill in the online warranty at [www.jrhome.com/warranty-registration](http://www.jrhome.com/warranty-registration) within 30 days of purchase to receive a complimentary extra year of warranty protection.

Follow us on:  
Suivez-nous sur



[www.jrhome.com](http://www.jrhome.com)

#paramount #jrhome

# IMPORTANT

For questions, concerns or problems with our product please email our customer service department:

**customercare@jrhome.com**

DATED PROOF OF PURCHASE REQUIRED FOR WARRANTY SERVICE

Si vous éprouvez des difficultés, ou si vous avez des questions ou des préoccupations, prière de faire parvenir un courriel à notre Service à la clientèle

**customercare@jrhome.com**

UNE PREUVE D'ACHAT DATÉE EST REQUISE POUR SE PRÉVALOIR DE LA GARANTIE.

## WARRANTY

This product is inspected, tested and carefully packaged to minimize the chance of damage during shipment. If a part (excluding light bulbs, glass and fuses\*) within one year from the date of purchase proves to be defective in material or fabrication under normal use, the part will be repaired or replaced. The Company's obligation under the warranty is to replace or repair defective parts at our discretion. Any expenses or damage resulting from the installation, removal or transportation of the product will be the responsibility of the owner and are not covered by this warranty. The owner assumes all other risks arising from the use or misuse of the product. The warranty will be void if the product damage or failure is deemed by the Company to be caused by accident, alteration, misuse, abuse, incorrect installation or removal, or connection to an incorrect power source by the owner. The Company neither assumes, nor authorizes any person or entity to assume for it any obligation or liability associated with its products. Light bulbs and fuses are not covered under this warranty. If you have any questions regarding the warranty or service, please contact us at **customercare@jrhome.com**

Customer Service:

JR Home Products

Unit 306 - 19100 Airport Way, Pitt Meadows, BC V3Y 0E2

Toll Free: 1-800-561-5550

E-mail: **customercare@jrhome.com**

## AVERTISSEMENT

Ce produit a été soigneusement inspecté, testé et emballé afin de minimiser les risques de dommages durant le transport. Si l'une des pièces (à l'exception des verre, des ampoules électriques et des fusibles\*) s'avère défectueuse au niveau de sa fabrication ou de ses matériaux dans l'année qui suit la date de l'achat suite à une utilisation normale, la pièce sera réparée ou remplacée. La compagnie est tenue de réparer ou remplacer les pièces défectueuses à sa discrétion, en vertu de la garantie. Tout frais ou dommage résultant de l'installation, du démantèlement ou du transport du produit demeure la responsabilité du client et n'est pas couvert par cette garantie. Le client assume tout autre risque résultant de l'utilisation, correcte ou fautive du produit. La garantie devient nulle si la compagnie détermine que le dommage ou le mauvais fonctionnement est causé par un accident, une modification, une mauvaise utilisation, un abus, une mauvaise installation ou un mauvais démantèlement ou un branchement à une source électrique inadéquate de la part du client. La compagnie n'est pas responsable et n'autorise quiconque, personne ou entité légale, à accepter de responsabilité ou obligation en son nom, en rapport avec ses produits. \* Les ampoules électriques et les fusibles ne sont pas couverts par cette garantie. Pour toute question au sujet de la garantie ou du service, envoyez-nous un courriel à: **customercare@jrhome.com**.

Service à la clientèle :

JR Home Products

Unit 306 - 19100 Airport Way, Pitt Meadows BC V3Y 0E2

Toll Free: 1-800-561-5550

E-mail: **customercare@jrhome.com**

**You MUST register your product within 30 days to receive warranty service.**

**Registration can be completed online at [customercare@jrhome.com](mailto:customercare@jrhome.com) or by mailing this form.**

**Vous DEVEZ enregistrer votre produit dans les 30 jours pour utiliser la garantie.**

**L'enregistrement sera complet une fois que vous aurez posté ce formulaire ou s'inscrire en ligne à :**

## Warranty Registration Information Form / Formulaire d'enregistrement de la garantie

Name / Nom: \_\_\_\_\_

Street / Adresse: \_\_\_\_\_

City / Ville: \_\_\_\_\_

Province / Province: \_\_\_\_\_

Postal Code / Code postal: \_\_\_\_\_

Daytime Phone # / No téléphone jour: \_\_\_\_\_

Evening Phone # / No téléphone soir: \_\_\_\_\_

E-Mail Address / Courriel: \_\_\_\_\_

Product/Produit: \_\_\_\_\_

Place of Purchase / Lieu de l'achat: \_\_\_\_\_

Date of Purchase / Date de l'achat: \_\_\_\_\_

Model # / No de modèle: \_\_\_\_\_

Serial # / Numéro de série: \_\_\_\_\_

You MUST register your product to receive warranty service.

For warranty service, contact J&R Home Products at the address, phone numbers listed below within 30 days of purchase. Be sure to have your sales receipt and original date of purchase. All warranty service will be coordinated by J&R Home Products service center.

Vous DEVEZ enregistrer votre produit pour vous prévaloir de la garantie.

Afin de faire valoir la garantie, communiquez avec J&R Home Products à l'adresse et aux numéros indiqués ci-dessous dans les 30 jours suivant la date d'achat. Ayez en main votre reçu et la date d'achat. Toutes les demandes liées aux garanties seront traitées par le centre de service de J&R Home Products.

# CONVERTING FROM LIQUID PROPANE (LP) TO NATURAL GAS (NG) *Paramount*

## WARNING

MAKE SURE ALL CONTROL KNOBS & CYLINDER VALVE ARE IN OFF POSITION BEFORE CONVERTING.

This appliance is portable and shipped from the factory for use with Liquid Propane (LP Gas), which is delivered to the grill from removable tanks (LP tanks and their use are covered elsewhere in this manual). If a Natural Gas connection is available, the user may wish to change the gas delivery system to the more permanent Natural Gas supply.

This appliance is certified for use with either Liquid Propane (LP Gas) or Natural Gas and comes complete with the necessary parts to convert the appliance for use with Natural Gas hose and regulator (sold separately). The conversion valves allows the use of Natural Gas without replacing the burners or entire valve system.

A qualified gas technician is required to do the conversion. Your warranty may be voided if the conversion is improperly completed. Please retain the parts supplied with the appliance and these instructions so the technician can do the conversion.

### Orifice Chart

The different burner valves in this appliance have different BTU ratings. The holes in the fittings are orifices themselves drilled to different sizes so as to allow the proper amount of gas to flow through them. Please note the chart below to give an easy reference for the various orifice opening sizes for the different valves in the appliance.

Propane (manifold pressure 11")		NG (manifold pressure 7")	
Orifice Size	Input Rate [BTU/h]	Orifice Size	Input Rate [BTU/h]
2.3mm	55000	3.78mm	55000

NG Hose and Regulator Conversion tools required:

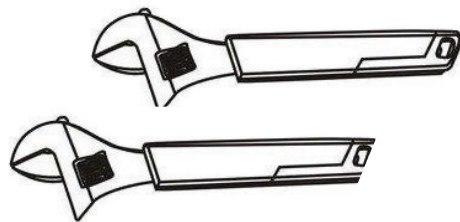

Adjustable Wrench (2)

## WARNING

Make sure all appliance components are completely cooled and gas supply is turned off and removed from the appliance prior to performing the conversion.

**WARNING!** To avoid the possibility of burns conversions should only be done when the burner is turned off. Turn gas off at source and disconnect the burner before beginning conversion.

**WARNING!** This conversion must be performed by a licensed gas fitter and all connections must be leak tested before operating the appliance.

Your burner comes from the factory set up for propane but it can be easily converted to natural gas by following these steps:

1. Disconnect the flex line from the burner using wrench.



2. Remove orifice connector using wrench.

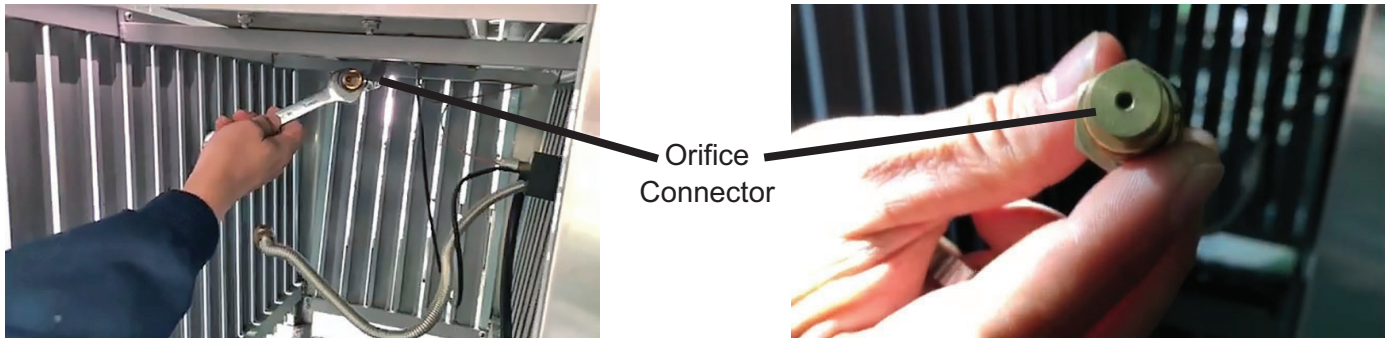

3. Install the natural gas air shutter from the parts bag.

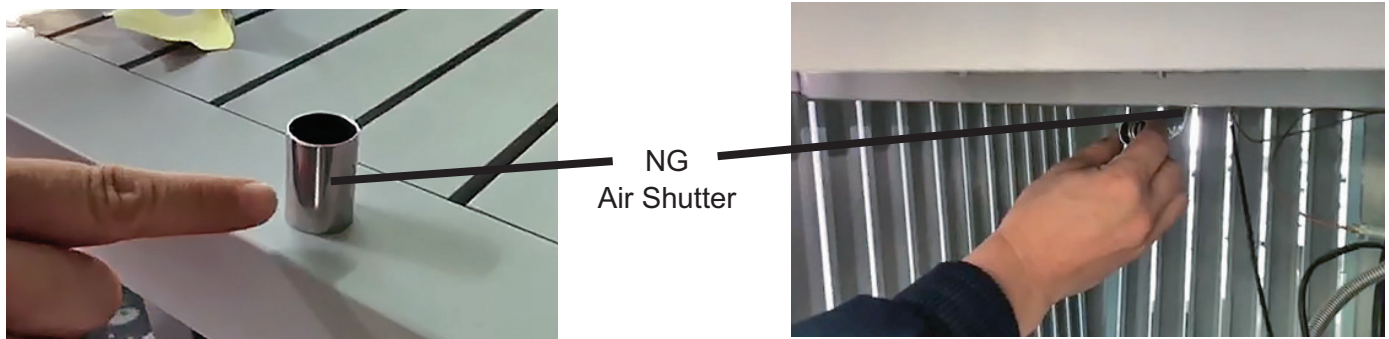

4. Separate the two parts of the orifice connector by using two wrenches.

Orifice Connector



5. Replace the propane orifice with the natural gas orifice and retighten with wrenches.

Natural Gas Orifice



6. Insert the Orifice holder into the air shutter. Re-attach flex hose. Tighten with wrench.

Orifice Connector  
in Air Shutter



7. Connect NG hose to the burner control with a wrench. Connect the quick connect adapter to the NG supply valve.



Quick Connect Natural Gas Adapter  
(Not Included)

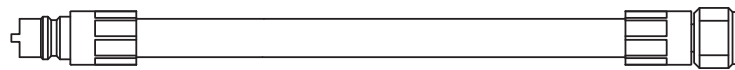

Quick Connect Natural Gas (NG) Hose  
(Not Included)

PART# NL-NGHOSE  
[www.paramountathome.com](http://www.paramountathome.com)

8. Connect the NG hose to the Quick Connect adapter.

9. Fill out the conversion label included with your burner and apply it to the inside of the control panel access door.

**A leak test must be performed according to the leak testing instructions found in the manual.**

***Natural Gas Hook-Up***

The gas appliance is designed to operate at an inlet pressure of 7 inches water column. The piping up to the appliance is the responsibility of the installer. Connect the inlet valve to rigid pipe, copper tube or an approved flexible metal connector, which complies with Z21.4/CSA 6.10. If using a gas hose(not supplied) connect the flared end of the hose to the connector on the end of the inlet valve. Tighten using two wrenches. (Do not use thread sealer/pipe dope.) Leak test all joints prior to using the appliance. Piping and valves upstream of the quick disconnect are not supplied. The gas supply pipe must be sufficiently sized to supply the BTU/h specified on the rating plate, based on the length of the piping run. The quick disconnect must not be installed in an upward direction and a readily accessible manual shut-off valve must be installed upstream of, and as close to, the quick disconnect as is feasible.

**Purge the gas supply line of any trapped air prior to the first firing of the unit.**

**WARNING!**

- The installation must be performed by a licensed gas fitter, and all connection must be leak tested before operating the appliance.
- Ensure all hose connections are tightened using two wrenches. Do not use Teflon tape or pipe dope on any hose connection.
- Ensure the hose does not contact any high temperature surfaces or it may melt and leak causing a fire.
- Locate the hose out of pathways where people may trip over it or in areas where the hose may be subject to accidental damage.
- Leak test all the connections using a soap and water solutions as per the leak testing instructions found in the manual.